

Taper roller bearings, single row

Principal dimensions			Basic load ratings		Fatigue load limit Pu	Speed ratings		Mass	Designation
d	D	T	dynamic	static		Reference speed	Limiting speed		
mm			kN		kN	r/min		kg	* - SKF Explorer bearing
90	150	45	251	390	43	3000	4300	3,10	33118/Q

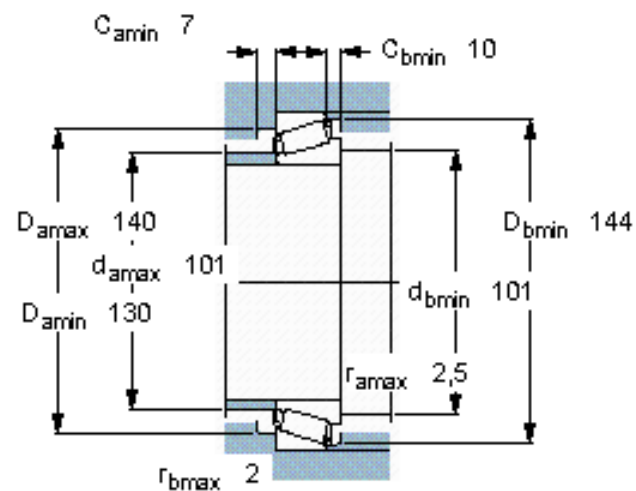
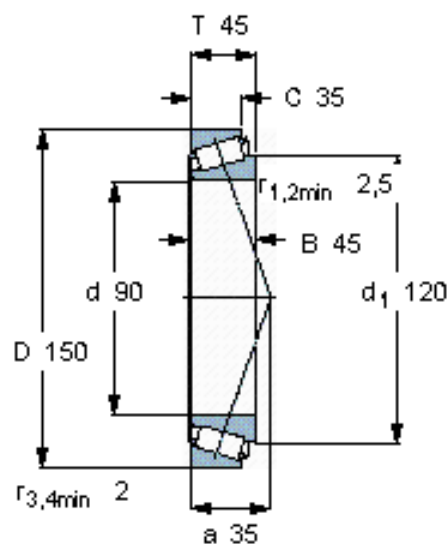

Calculation factors

e 0,4
 Y 1,5
 Y₀ 0,8