

Taper roller bearings, single row

Principal dimensions			Basic load ratings		Fatigue load limit Pu	Speed ratings		Mass	Designation
d	D	T	dynamic	static		Reference speed	Limiting speed		
mm			kN		kN	r/min		kg	* - SKF Explorer bearing
100	180	49	319	440	48	2600	3600	4,90	32220 J2

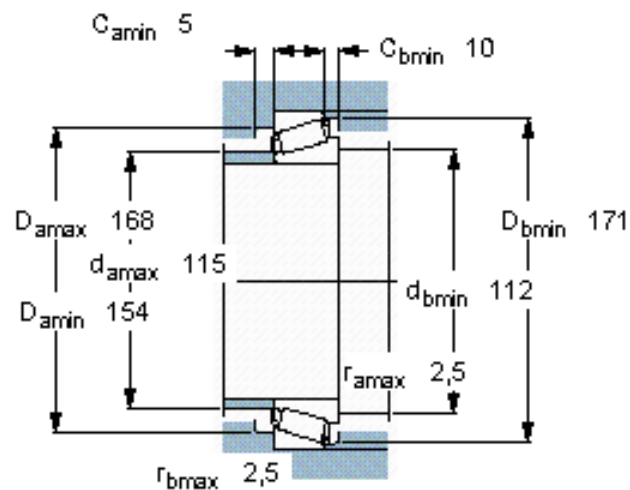
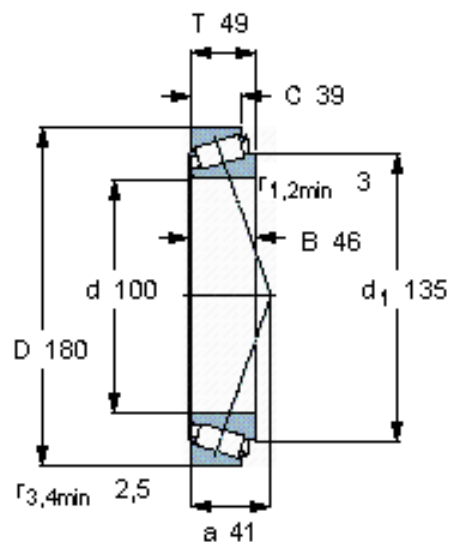

Calculation factors

e 0,43

Y 1,4

$Y_0 0,8$