

### Taper roller bearings, single row

Principal dimensions			Basic load ratings		Fatigue load limit Pu	Speed ratings		Mass	Designation
d	D	T	dynamic	static		Reference speed	Limiting speed		
mm			kN		kN	r/min		kg	* - SKF Explorer bearing
30	55	17	35,8	44	4,55	9000	12000	0,17	32006 X/Q

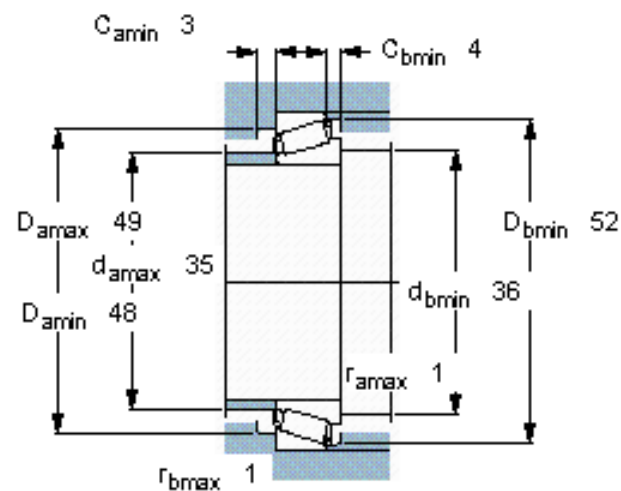
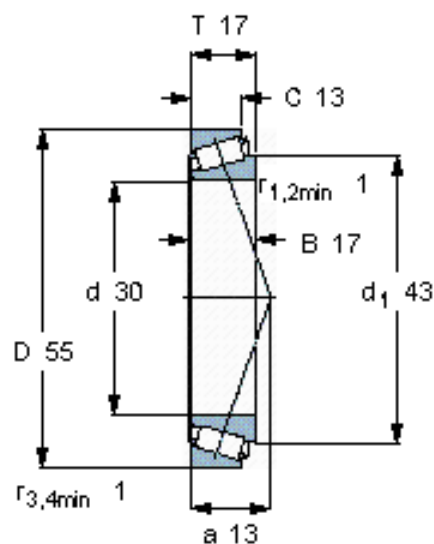

#### Calculation factors

e 0,43

Y 1,4

$Y_0$  0,8