

Spherical roller bearings, cylindrical and tapered bore

Principal dimensions			Basic load ratings		Fatigue load limit Pu	Speed ratings		Mass	Designation
d	D	B	dynamic	static		Reference speed	Limiting speed		
mm			kN		kN	r/min		kg	-
110	180	69	520	750	78	2200	3000	7,10	24122 CC/W33 *

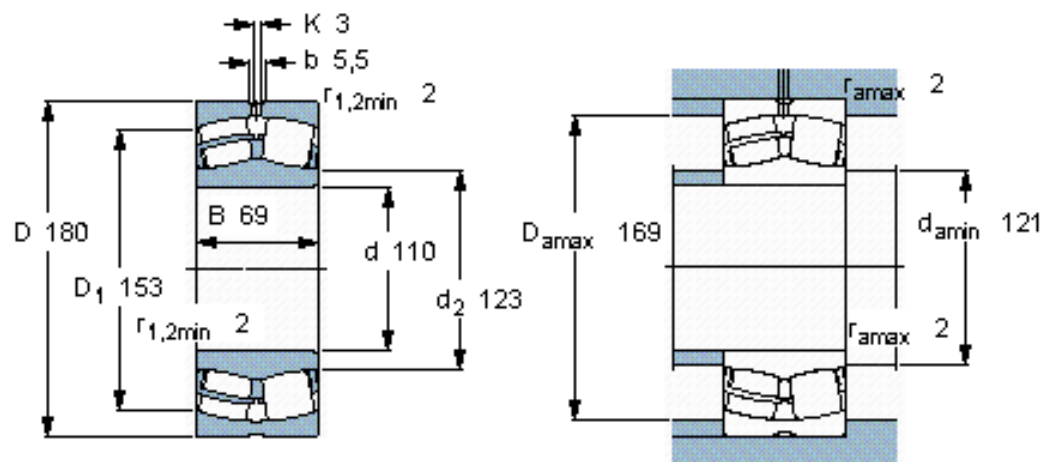

Calculation factors

$e = 0,37$
 $Y_1 = 1,8$
 $Y_2 = 2,7$
 $Y_0 = 1,8$