

Spherical roller bearings, cylindrical and tapered bore

Principal dimensions			Basic load ratings		Fatigue load limit Pu	Speed ratings		Mass	Designation
d	D	B	dynamic	static		Reference speed	Limiting speed		
mm			kN	C0	kN	r/min	kg		* - SKF Explorer bearing
280	580	175	4000	5200	365	800	1100	235	22356 CC/W33 *

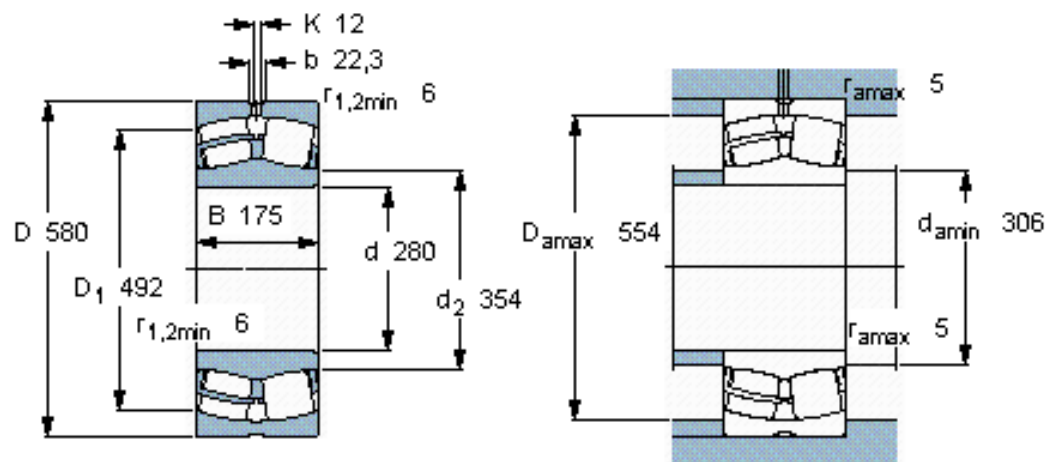

Calculation factors

e 0,30
 Y_1 2,3
 Y_2 3,4
 Y_0 2,2