

Spherical roller bearings, cylindrical and tapered bore

Principal dimensions			Basic load ratings		Fatigue load limit Pu	Speed ratings		Mass	Designation
d	D	B	dynamic	static		Reference speed	Limiting speed		
mm			kN		kN	r/min		kg	-
70	150	51	400	430	45	3400	4500	4,55	22314 E *

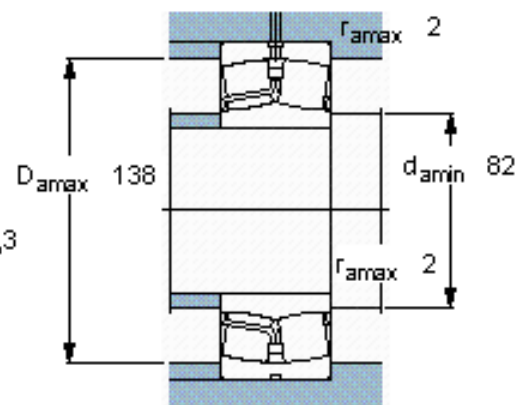
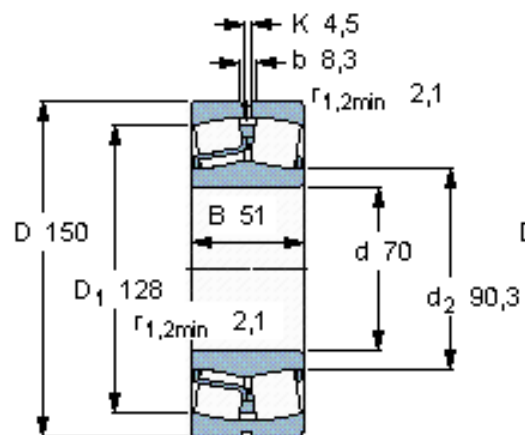

Calculation factors

e 0,33
 Y_1 2
 Y_2 3
 Y_0 2