

Spherical roller bearings, cylindrical and tapered bore

Principal dimensions			Basic load ratings		Fatigue load limit Pu	Speed ratings		Mass	Designation
d	D	B	dynamic	static		Reference speed	Limiting speed		
mm			kN		kN	r/min		kg	-
65	140	48	340	360	38	3800	5000	3,75	22313 E *

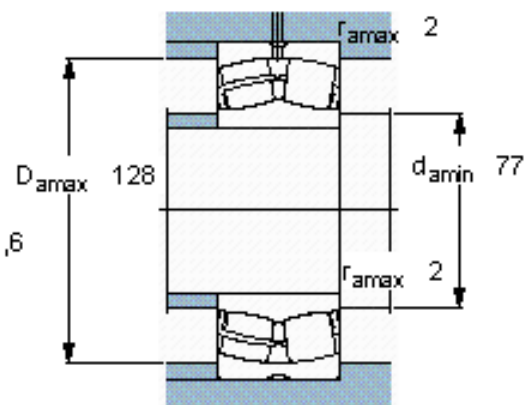
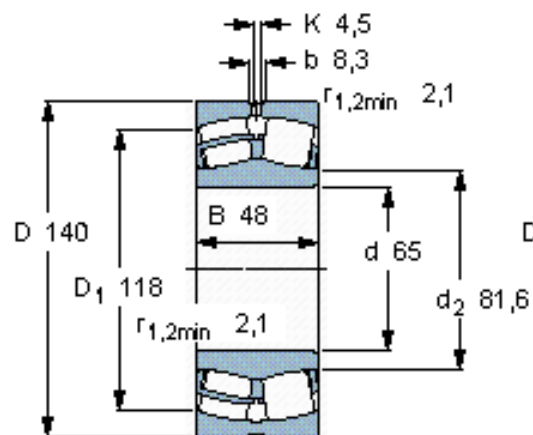

Calculation factors

e 0,35
 Y_1 1,9
 Y_2 2,9
 Y_0 1,8