

Spherical roller bearings, cylindrical and tapered bore

Principal dimensions			Basic load ratings		Fatigue load limit Pu	Speed ratings		Mass	Designation
d	D	B	dynamic	static		Reference speed	Limiting speed		
mm			kN		kN	r/min		kg	-
80	170	39	325	375	39	3800	5300	4,40	21316 EK *

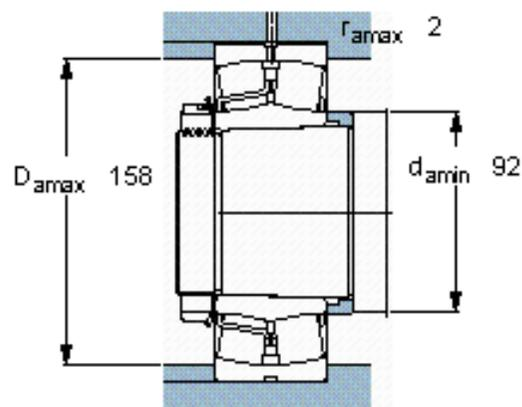
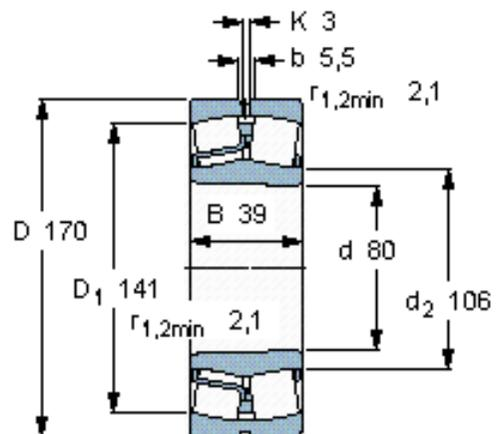

Calculation factors

e 0,24
 Y_1 2,8
 Y_2 4,2
 Y_0 2,8