

Deep groove ball bearings, single row

| Principal dimensions | | | Basic load ratings | | Fatigue load limit Pu | Speed ratings | | Mass | Designation |
|----------------------|----|----|--------------------|--------|--------------------------|-----------------|----------------|------|-------------|
| d | D | B | dynamic | static | | Reference speed | Limiting speed | | |
| mm | | | kN | | kN | r/min | | kg | - |
| 10 | 30 | 14 | 5,07 | 2,36 | 0,1 | - | 17000 | 0,04 | 62200-2RS1 |

* - SKF Explorer bearing

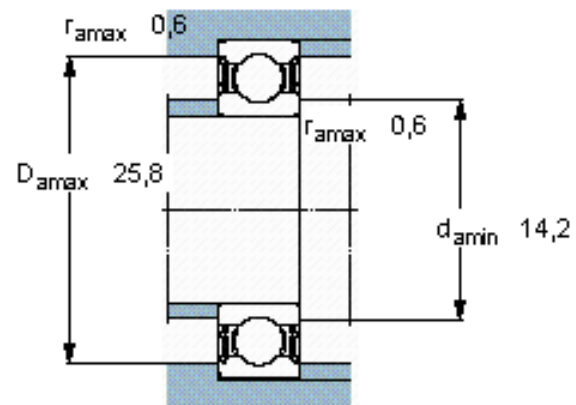
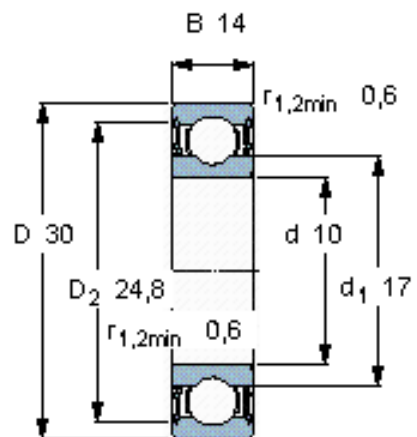

Calculation factors

k_r 0,025

f_0 13