

### Spherical roller bearings, cylindrical and tapered bore

Principal dimensions			Basic load ratings		Fatigue load limit Pu	Speed ratings		Mass	Designation
d	D	B	dynamic	static		Reference speed	Limiting speed		
mm			kN		kN	r/min		kg	-
380	680	240	5850	9150	620	500	750	365	23276 CAK/W33 *

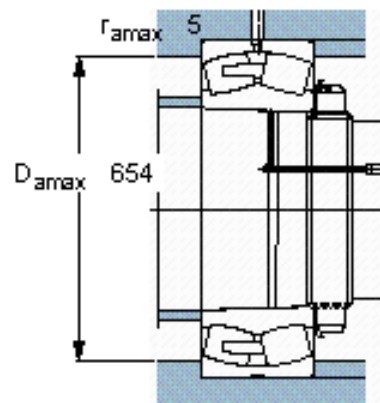
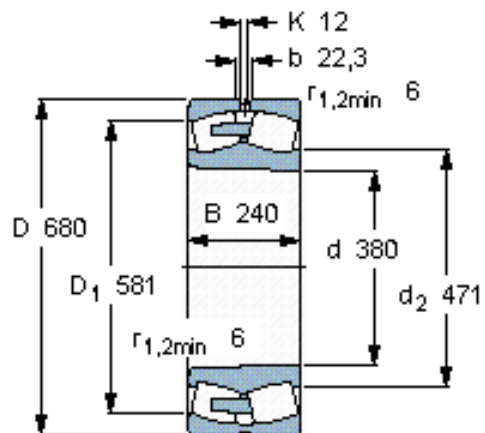

#### Calculation factors

$e$  0,35  
 $Y_1$  1,9  
 $Y_2$  2,9  
 $Y_0$  1,8