

### Spherical roller bearings, cylindrical and tapered bore

Principal dimensions			Basic load ratings		Fatigue load limit Pu	Speed ratings		Mass	Designation
d	D	B	dynamic	static		Reference speed	Limiting speed		
mm			kN		kN	r/min		kg	-
340	620	224	5100	7800	550	560	800	285	23268 CAK/W33 *

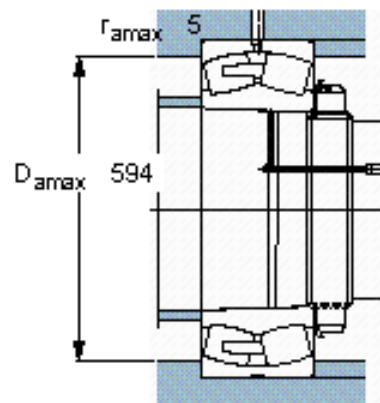
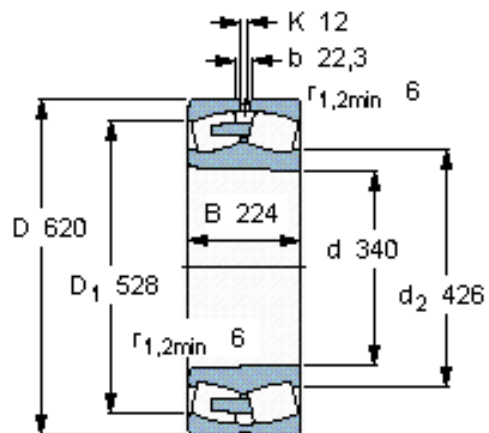

#### Calculation factors

$e$  0,35  
 $Y_1$  1,9  
 $Y_2$  2,9  
 $Y_0$  1,8