

Spherical roller bearings, cylindrical and tapered bore

Principal dimensions			Basic load ratings		Fatigue load limit Pu	Speed ratings		Mass	Designation
d	D	B	dynamic	static		Reference speed	Limiting speed		
mm			kN	C0	kN	r/min	kg		* - SKF Explorer bearing
260	480	174	3250	4750	360	850	1200	140	23252 CC/W33 *

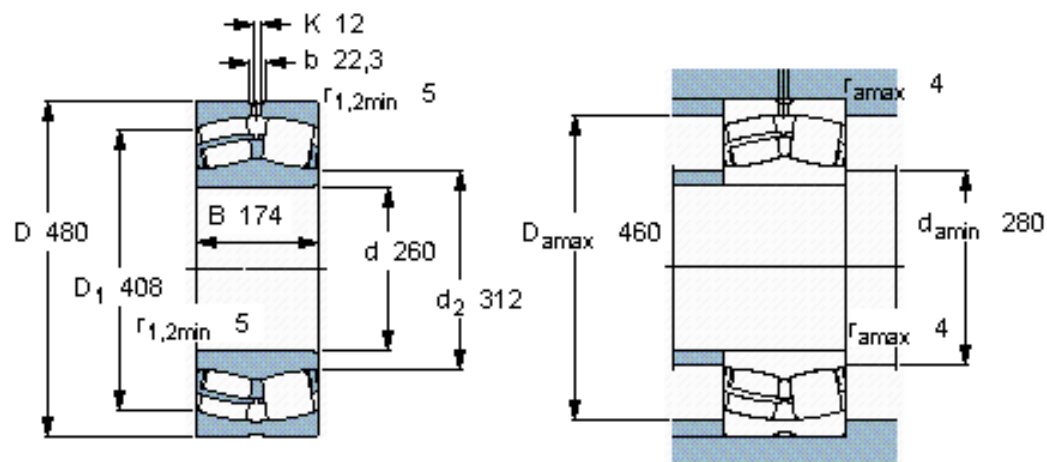

Calculation factors

e 0,35
 Y_1 1,9
 Y_2 2,9
 Y_0 1,8