

Spherical roller bearings, cylindrical and tapered bore

Principal dimensions			Basic load ratings		Fatigue load limit Pu	Speed ratings		Mass	Designation
d	D	B	dynamic	static		Reference speed	Limiting speed		
mm			kN	C0	kN	r/min	kg		* - SKF Explorer bearing
150	270	96	1080	1460	137	1600	2200	24,0	23230 CCK/W33 *

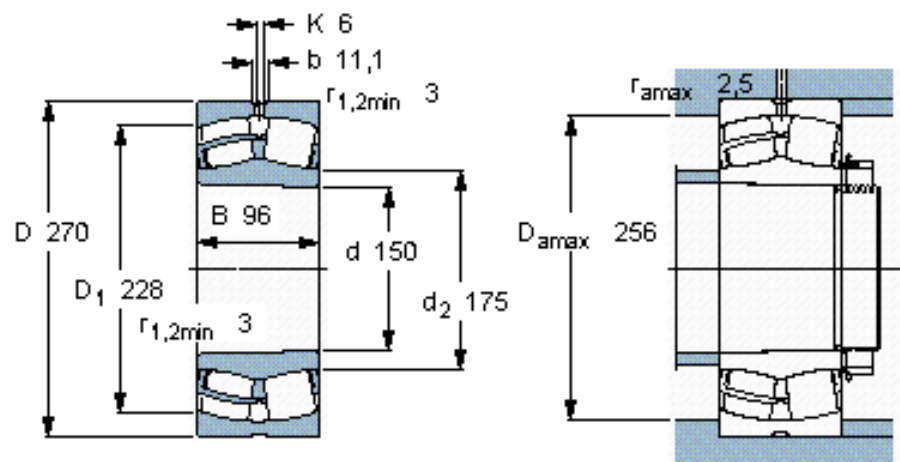

Calculation factors

$e = 0,35$
 $Y_1 = 1,9$
 $Y_2 = 2,9$
 $Y_0 = 1,8$