

Spherical roller bearings, cylindrical and tapered bore

Principal dimensions			Basic load ratings		Fatigue load limit Pu	Speed ratings		Mass	Designation
d	D	B	dynamic	static		Reference speed	Limiting speed		
mm			kN		kN	r/min		kg	-
480	700	165	3900	6800	450	530	950	210	23096 CAK/W33 *

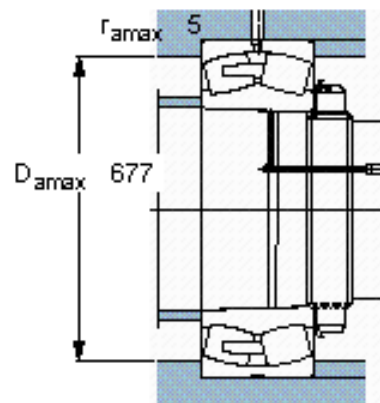
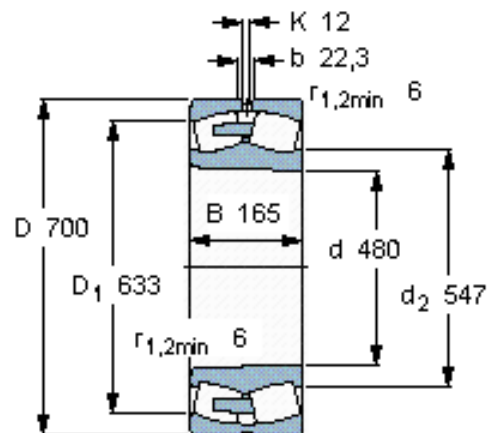

Calculation factors

e 0,21
 Y_1 3,2
 Y_2 4,8
 Y_0 3,2