

Spherical roller bearings, cylindrical and tapered bore

Principal dimensions			Basic load ratings		Fatigue load limit Pu	Speed ratings		Mass	Designation
d	D	B	dynamic	static		Reference speed	Limiting speed		
mm			kN	C0	kN	r/min	kg		* - SKF Explorer bearing
200	310	82	1000	1530	137	1800	2200	23,3	23040 CC/W33 *

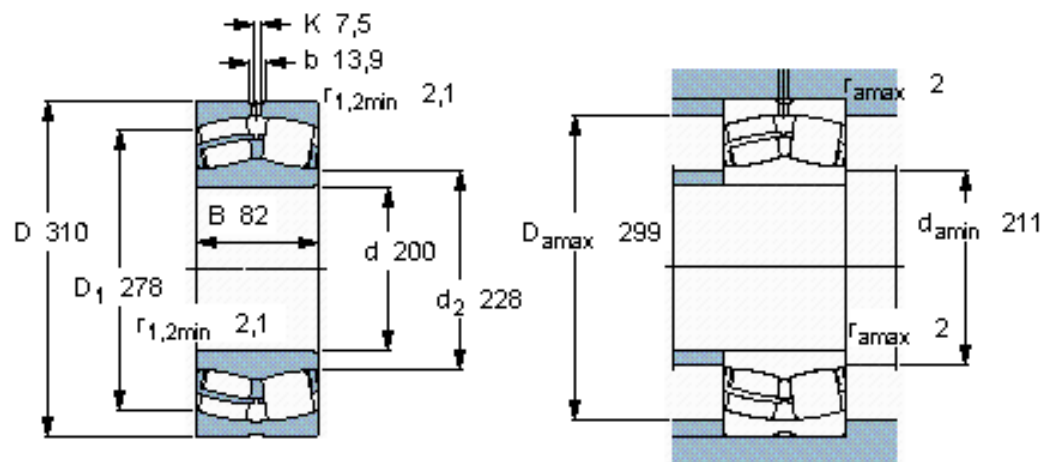

Calculation factors

e 0,24
 Y_1 2,8
 Y_2 4,2
 Y_0 2,8