

Spherical roller bearings, cylindrical and tapered bore

Principal dimensions			Basic load ratings		Fatigue load limit Pu	Speed ratings		Mass	Designation
d	D	B	dynamic	static		Reference speed	Limiting speed		
mm			kN	C0	kN	r/min	kg		* - SKF Explorer bearing
190	290	75	865	1340	122	1900	2400	18,0	23038 CC/W33 *

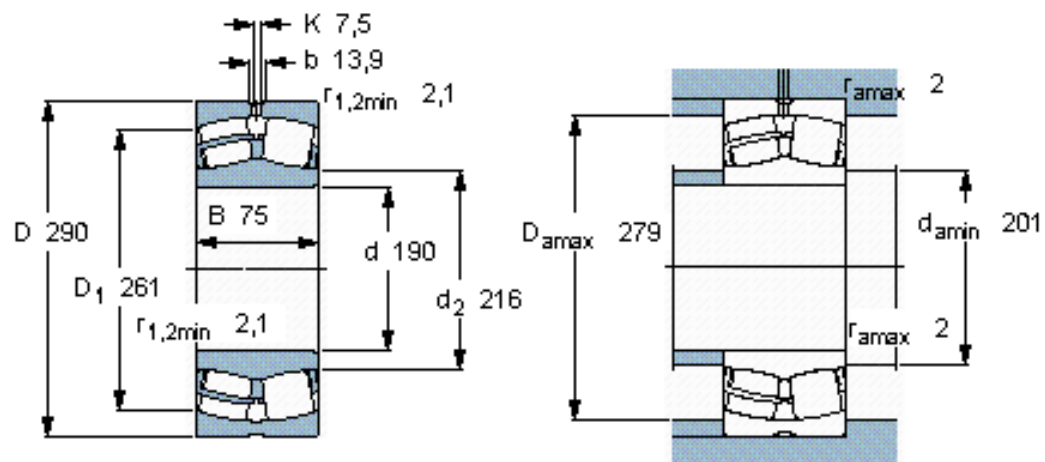

Calculation factors

e 0,23
 Y_1 2,9
 Y_2 4,4
 Y_0 2,8