

Spherical roller bearings, cylindrical and tapered bore

Principal dimensions			Basic load ratings		Fatigue load limit Pu	Speed ratings		Mass	Designation
d	D	B	dynamic	static		Reference speed	Limiting speed		
mm			kN		kN	r/min		kg	-
160	290	80	1000	1290	118	2000	2800	22,5	22232 CC/W33 *

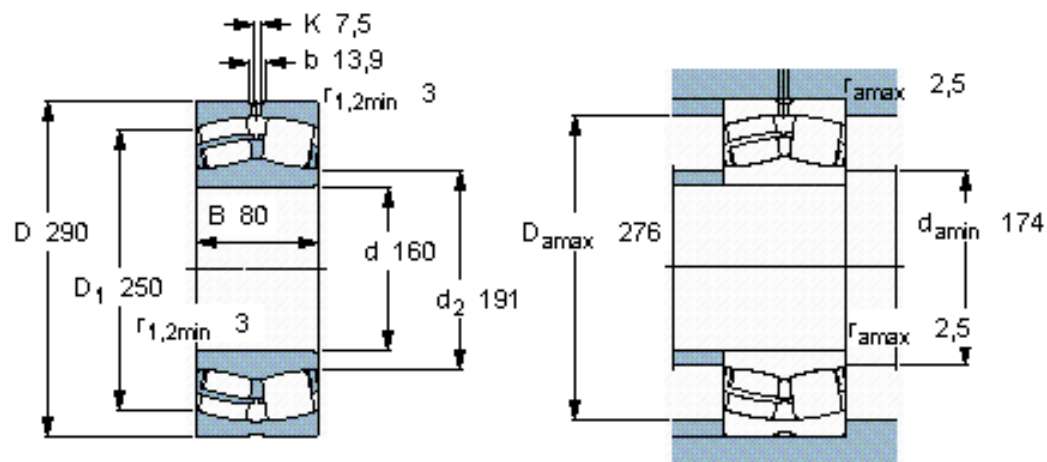

Calculation factors

e 0,26
 Y_1 2,6
 Y_2 3,9
 Y_0 2,5