

Spherical roller bearings, cylindrical and tapered bore

Principal dimensions			Basic load ratings		Fatigue load limit Pu	Speed ratings		Mass kg	Designation
d	D	B	dynamic	static		Reference speed	Limiting speed		
mm			kN		kN	r/min			* - SKF Explorer bearing
70	125	31	208	228	25,5	5000	6700	1,50	22214 EK *

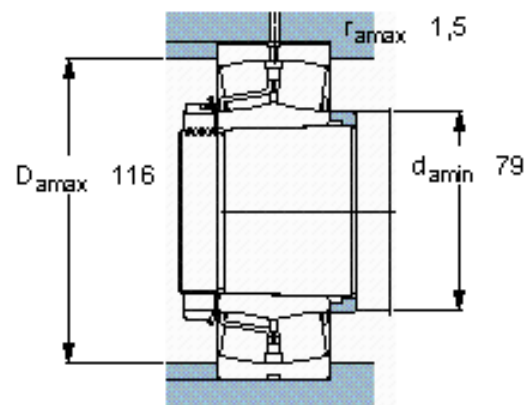
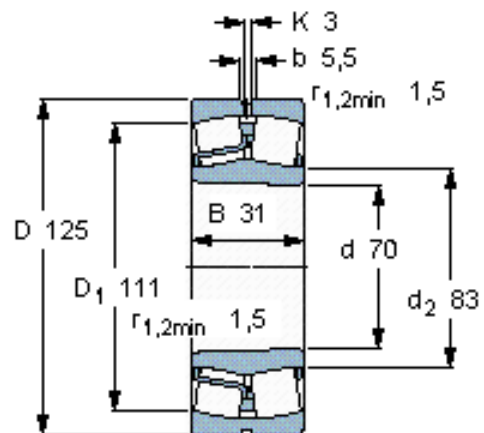

Calculation factors

e 0,23
 Y_1 2,9
 Y_2 4,4
 Y_0 2,8