

Spherical roller bearings, cylindrical and tapered bore

Principal dimensions			Basic load ratings		Fatigue load limit Pu	Speed ratings		Mass	Designation
d	D	B	dynamic	static		Reference speed	Limiting speed		
mm			kN		kN	r/min		kg	-
75	160	37	285	325	34,5	4000	5600	3,75	21315 E *

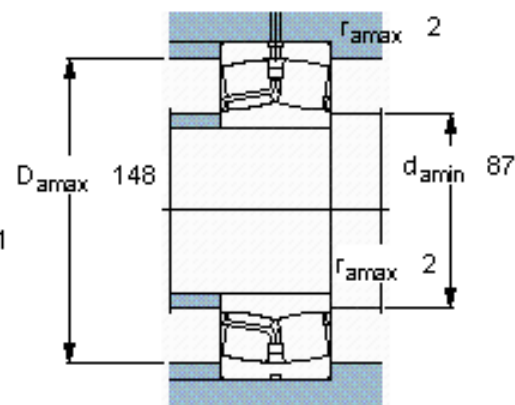
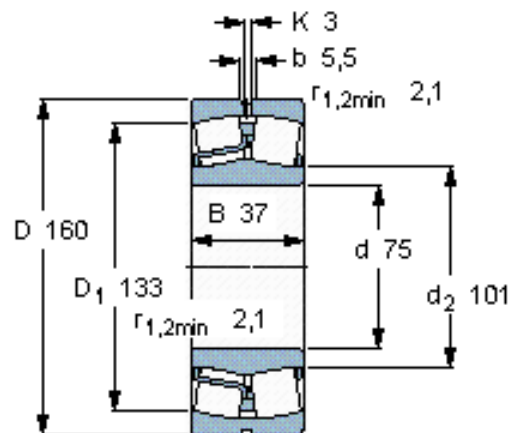

Calculation factors

e 0,22
 Y_1 3
 Y_2 4,6
 Y_0 2,8